

Warranty  
& Product  
Guide



LINEA DOMO

IN PURSUIT OF PERFECTION  
FURNITURE SINCE 2005

Product Care and Warranty.  
Please retain this Care Book  
for future reference.



PO BOX 6842  
Wetherill Park  
NSW 2164, Australia

T +61 2 9732 9666  
F +61 2 8003 9118  
[lineadomo.com.au](http://lineadomo.com.au)

Linea Domo – Part of  
Denai Group 2023  
V202306

# Contents

<b>1.0</b>	<b>General Care</b>	<b>5</b>
1.1	The Linea Domo Story	6
1.2	Understanding Your New Lounge	7
1.3	Most Common Characteristics of Genuine Leather	9
1.4	General Care Tips	10
1.5	Leather Care Tips	12
1.6	Fabric Care Tips	14
<b>2.0</b>	<b>Product Warranty</b>	<b>15</b>
2.1	Warranty Details	16
2.2	Manufacturer's Warranty Terms and Conditions	17
<b>3.0</b>	<b>Recliner</b>	<b>21</b>
3.1	About Reclining Mechanisms	22
3.2	Fixing Back on Recliner	23
3.3	Recliner Operating Instructions	24
3.4	Electric Recliner Operating Instructions	25
3.5	Lift Chair	27
3.6	Controllers	28
3.7	Troubleshooting & Warnings	30
<b>4.0</b>	<b>Sofa Assembly</b>	<b>31</b>
4.1	Sofa Bed	32
4.2	Standard Feet	34
4.3	Bracket	35
4.4	Croc Lock	37
4.5	Locking Clip	38



## 1.1 The Linea Domo Story

Proudly designed and manufactured exclusively for Australian families using only the finest materials and technology, including top grain cowhide leather. Because this Product is made in our own factory, we are able to control all facets of manufacture and supply to comply with the stringent standards set by the management of Linea Domo.

### OUR LEATHER

In the manufacturing of the complete Linea Domo product range, only top-grain cowhide leather is used on the finished Product. No split leather is used. Furthermore, the leather has passed tests of both Australian and European standards for colour fastness and rub testing for durability, as well as chemical tests to ensure it is safe and friendly for both your family and our environment.

### OUR RANGE

Our product range includes motion, function, contemporary and prestige categories. One outstanding feature of the collection for our customers is the ability to adapt ranges to fulfil your needs. Each lounge is custom-made to your selected colour and combination, and it is unique to you.

### QUALITY CONTROL

Believing in the delivery of quality is the culture of our organization; elaborate steps are undertaken at each and every stage of the manufacturing process to deliver an end product which is as perfect as it can be. Quality Control starts with the receipt of all raw materials, whether it is timber, foam, steel, fibre, fabric or leather and continues till the end with packing and dispatch.

### OUR SERVICE

Whether you buy a relaxing recliner, a contemporary settee, or a traditional comfy sofa, we will ensure that you receive a quality product. Should The Product needs service for any reason, our nationwide service team is there to ensure your satisfaction.

We are dedicated to the complete process of manufacturing to the needs of our customers, and while we are constantly striving to become the best Manufacturer of quality furniture at a realistic price to the local market, we will always have a global vision. We are convinced our dedication will result in your satisfaction for many years to come.

## 1.2 Understanding Your New Lounge

We want to make sure your lounge gets to you in the best possible condition, so we package it well to protect it on its journey to your home. During the journey, a few crush marks may appear on your lounge, but please do not be alarmed; these will naturally work their way out over a few weeks.

If your new Linea Domo sofa feels or looks a little different to the one you saw in the store (the seat may feel firmer; the leather may look tighter), that's because your furniture is brand new, unlike the store's floor sample which may have already been well 'run-in' by many visitors. Like a new pair of shoes or a saddle, with regular use, your new furniture will also gradually begin to adapt to your expectations.

### WHAT TO EXPECT WITH USE

An advantage to bear in mind is that a fine sofa or chair doesn't wear out; it wears in. This also means that your sofa can (and will) relax into a more casual appearance over time. When pressure is applied to the polyurethane foam for the first time, the microcells within the foam structure break, which creates a slight softening effect. This natural cellular breakdown is expected. It also means that during the first few weeks of use, comfort creases and wrinkles will form naturally in the leather. These characteristics give it a soft, inviting look that is an inherent feature of the best leather upholstery.

### THE BEAUTY OF GENUINE LEATHER

Your Linea Domo lounge features unique and handmade signatures that individually personalise every design. Just as no two fingerprints are alike, each piece of leather is distinctive in its markings. These markings add beauty to the leather and serve as proof of its authenticity. Leather is a natural material, so every hide has unique characteristics, and as our furniture is made from many hides, the leather may show slight colour and grain variation — this is only natural.

Age adds character and reflects how leather furniture has been used during its lifetime. Over the years, leather adapts itself to the user and develops its own personal look.

With regular use, as the leather fibres relax, we expect that comfort creases may form in the areas that receive the most body contact, such as the seat and back cushions. All these signs serve as more evidence of the leather's authenticity and should be no cause for concern.



#### VILLA AND PREMIUM LEATHER RANGE

These leather ranges use the strong top-grain layer from quality cattle hide, but these hides may have shown excessive marks, scars, insect bites, nicks etc. To be used for selected Linea Domo upholstery, the impact of these irregularities need to be reduced, usually by lightly buffing (sanding and filling) the hides damaged top-grain surface. A uniform grain pattern is then embossed into the leather to restore an overall 'even grain' look. Our corrected grain leathers are both strongly and carefully finished to enhance their look and wear and provide excellent value for money as day-to-day leather furniture covers, perfect for families.

#### VINTAGE LEATHER RANGE

This article, with its unique finish, is designed for people who love the natural characteristics of genuine leather. The irregularity of the grain and colour highlights its elegance and individuality. In this kind of article, you can find slight imperfections, like closed scratches or wrinkles, which highlight its originality, and this can be considered a guarantee of the naturalness of the treatments.

Due to its special characteristics, this leather requires a little more maintenance. To help extend the life of this beautiful Product, the upholstery should be lightly cleaned with a clean, dry cloth on a regular basis to remove dust and accumulated dirt.

Please be aware that the vintage leather range is designed to develop a distressed look with use. Oiled and waxed leather gets traces or patina after a very short period of usage. That is the desired effect of this type of leather.

Please refer to page 12 for leather care tips.

### 1.3 Most Common Characteristics of Genuine Leather

As a natural product, good quality leather will have different markings—a guarantee of being genuine and what makes your sofa unique. Some other examples of the characteristics you can expect to see with leather upholstery are:

Vein lines



Grain variation



Colour variation



Skin blemishes



#### DESIRED EFFECT

Oiled and waxed leather get traces or patina after a very short period of usage. That is a desired effect of this type of leather as shown below.



Stretching

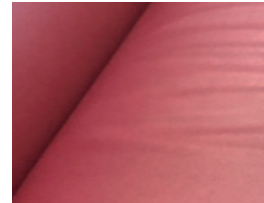

Horn butts, scrapes & scars



Fat Wrinkles

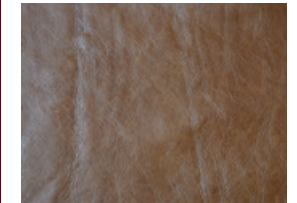

## 1.4 General Care Tips

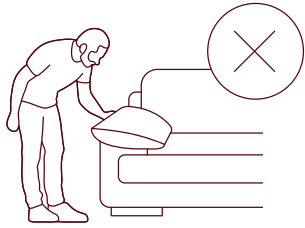

When moving your sofa, do not lift it by the cushions sewn to the frame or move your sofa by dragging it around. The best way is to lift it from the base.

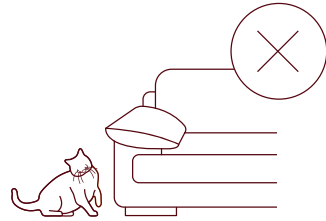

If you have pets, please be careful with them around your lounge. Pets can damage your lounge through chew marks, claws and oil residue from their fur, all of which are not covered by our warranty terms.

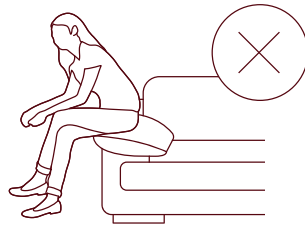

As tempting as it may be, armrests and backrests are not designed as seating.

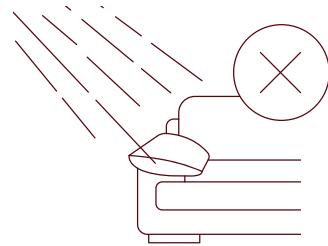

To avoid your sofa from fading, it is best not to expose it to direct sunlight.

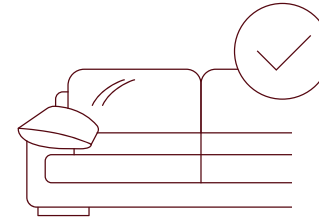

During the first three months, foam padding will become softer. Light creases may form on the cover following this. This is to be considered normal wear.

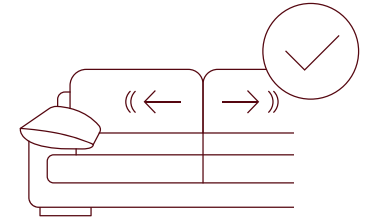

To keep your sofa looking its best, you should plump and shape it regularly to ensure padding and upholstery return to their initial appearance.

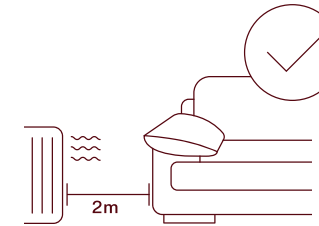

Your sofa should be placed at least 2 meters away from any heat source.

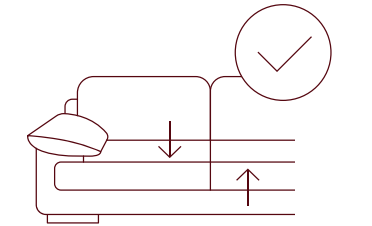

For even wear, you should alternate your choice of seat. All seating foams are designed to absorb the seated weight loads in the centre of the cushion; sitting or lying on the edges and sides of the cushion can cause the breakdown of the foams, causing them to flatten and lose their density, firmness and form.

## 1.5 Leather Care Tips

A regular routine of protection and cleaning will not only help protect your furniture from stains and damage, but it will also add years to its life. Some types of soiling only affect the way your furniture looks; others can actually damage the leather. Dust and perspiration are both particularly damaging. Dust is abrasive: it acts like sandpaper. Over time dust can cause serious damage to the furniture's topcoat.

Perspiration and body oils contain salts, enzymes and fatty acids, all of which can stain and damage leather and its topcoat. It is important to prevent perspiration and body oils from building up. Particular care needs to be taken if you regularly take medications, as they can increase the damage caused by perspiration and body oils.

- Clean the leather regularly with a soft damp white, colour-fast cloth to remove grease, dirt and dust.
- To remove dry stains, sweep them off carefully with a clean hand or with an extremely soft brush.
- To remove liquid stains, blot the surface by dabbing carefully with a paper towel, do not press hard, as this could push the stain into the pores of the leather.
- DO NOT use soap, saddle soaps, oils, all-purpose cleaners, detergents, solvents, spray cleaners or abrasive cleaners on your leather furniture.
- DO NOT dry the leather in direct sunlight or with a hair dryer.

### ADDITIONAL CARE TIPS FOR VINTAGE LEATHER

Besides the above General Leather Care Tips, Vintage Leather with a wax finish will occasionally need to be revitalised if your furniture is starting to look scratched, scuffed or faded; then it is time to revitalise.

- Wipe contact areas with a clean damp cloth regularly.
- Clean with an approved Mild Leather cleaner 3 – 4 times per year.
- Apply an approved pullup leather rejuvenation cream when needed.
- Following cleaning or the application of rejuvenation cream, protection cream should be reapplied.
- Remove spills immediately to avoid staining.

Your Harvey Norman Sales Team Member can advise the correct products to maintain your purchase.



## 1.6 Fabric Care Tips

- Vacuum regularly with an upholstery attachment, using low suction.
- Spot clean where necessary.
- Treat spills and stains as soon as possible. Gently remove any soil or mop any liquid from the surface of the fabric. Do not saturate the fabric or filling with water or any other cleaning fluids. Seek professional advice from a fabric cleaning specialist.

Pilling can occasionally occur as a result of normal daily wear and should not be considered a fault. It can be successfully and easily removed with a battery-operated pilling tool available from most haberdashery stores. “De-pilling” only removes unsightly surface fibres, does not affect fabric performance, and is generally permanent.

### A SPECIAL NOTE ON LEATHER AND FABRICS

The leather/fabric warranties in this booklet do not apply where there is evidence of excessive soiling, improper cleaning, or abuse or where the leather/fabric has had a chemical treatment applied by the retail dealer or consumer which has not previously been approved in writing by Linea Domo. Please do not move furniture by pulling on leather or fabric.

**Medications:** If leather furniture is used constantly by individuals on some medications (including, but not limited to, chemotherapy, blood pressure and heart medications), extra care should be taken to protect leather surfaces from direct skin contact as the chemistry in these medications may react with and damage the leather finish. Headrest covers and arm protectors are advisable.

Sharp items can easily scratch the surface of the leather; this will add to the distressed appearance yet can be mostly remedied with the application of a speciality revitalising cream.

## 2.0

## Product Warranty



## 2.1 Warranty Details

### WARRANTY PERIOD

Subject to terms and conditions on pages 17–20.

#### 1. FRAME WARRANTY

The internal frame construction (including webbing and springs) of Linea Domo lounge furniture has been covered against manufacturing and material defects for ten (10) years. This is provided that the defect is not a result of normal wear and tear or a natural characteristic of the material used.

#### 2. LEATHER WARRANTY

The leather upholstery of Linea Domo sofas is covered against splitting and tearing due to manufacturing and material defects for a period of two (2) years. This is provided that the defect is not a result of normal wear and tear or a natural characteristic of the material used.

#### 3. FABRIC WARRANTY

The fabric upholstery of Linea Domo sofas is covered against manufacturing and material defects for a period of one (1) year. This is provided that the defect is not a result of normal wear and tear or a natural characteristic of the material used.

#### 4. SEATING FOAM WARRANTY

All foam used in the seat cushions of Linea Domo sofas is covered against material or manufacturing defects for a period of ten (10) years. Softening of foam should be expected as a result of normal use and is not to be confused with loss of resilience.

#### 5. RECLINER WARRANTY

The recliner mechanism is covered against manufacturing defects for a period of three (3) years. The recliner trigger or handle is covered against manufacturing defects for a period of one (1) year.

#### 6. ELECTRICAL PART WARRANTY

Any electrical part used in Linea Domo products is covered against defect for a period of one (1) year, which includes electrical/lift chair motor, Transformer, remote control, ER touch buttons, lights, smart cup holders, voice controls, USB ports etc.

#### 7. SOFA BED, HEADREST MECHANISM, BACKREST MECHANISM WARRANTY

The sofa bed mechanism, mattress, headrest mechanism and backrest mechanism are covered against manufacturing defects for a period of two (2) years.

#### 8. COMPONENT AND WORKMANSHIP WARRANTY

Back cushion foam and dacron, armrest foam and dacron, feather cushion, and workmanship (stitching, staples, legs, zipper, croc-lock, dust cover, calico, studs etc.) of Linea Domo sofas are covered against defects for a period of one (1) year.

## 2.2 Manufacturer's Warranty Terms and Conditions

The following terms and conditions relating to the purchase of our furniture products (Product) manufactured by us (Jinao International Holding (Australia) Pty Ltd ACN 107 665 387 trading as Linea Domo of Unit A 120 Hassall St, Wetherill Park NSW 2164) and purchased by you.

### 1. STATUTORY GUARANTEES AND RIGHTS

Our goods come with guarantees that cannot be excluded under the Australian Consumer Law (ACL). You are entitled to a replacement or refund for a major failure and compensation for any other reasonably foreseeable loss or damage. You are also entitled to have the goods repaired or replaced if the goods fail to be of acceptable quality, and the failure does not amount to a major failure.

In addition to the rights and remedies set out in this Manufacturer's Warranty, you are entitled to bring an action directly against us as the Manufacturer of the Product for damages in the circumstances set out in the ACL. The Manufacturer's Warranty is not intended in any way to limit or exclude such rights and remedies that you may have under law.

### MANUFACTURER'S WARRANTY

Our Manufacturer's Warranty:

- is not intended to change or exclude any statutory consumer rights that cannot be lawfully changed or excluded;
- is independent of any warranty that may be provided by the seller, for which it carries sole responsibility; and
- does not affect your rights against the seller, including any mandatory statutory rights you may have against the seller under the ACL. All other conditions and warranties expressed or implied are hereby excluded. No other person or persons (including our employees) are authorised by us to offer or give on our behalf any other or greater warranty than that given by us under this Manufacturer's Warranty.

In addition to any other rights that you may have under the ACL, we offer you a Manufacturer's Warranty on the following terms and conditions:

- a. we warrant that the Product will be free from defects in workmanship and materials;
- b. the warranty above applies for the warranty periods set out on page 16 of this booklet from the original delivery date of the Product (Warranty Period), regardless of whether a replacement has been provided under this warranty during the Warranty Period;

- c. if the Product fails during normal and proper use within the Warranty Period, we will repair or replace the defective parts of the Product, or the Product itself, with new parts or products that are functionally equivalent or superior to those originally supplied; and
- d. all components or Products repaired or replaced by us will be under warranty for the remaining period of the Warranty Period. The decision whether to repair or replace a Product under this Manufacturer's Warranty is at our sole discretion. This Manufacturer's Warranty is not transferable and applies to the original purchaser only. The Manufacturer's Warranty is voided if the Product is resold or transferred, or given to a new owner.

## 2. WHEN THE MANUFACTURER'S WARRANTY WON'T APPLY

Our Products are intended for domestic or household use only, and this Manufacturer's Warranty does not cover damage arising from the use of the Product in commercial, rental trade, institutional or other non-residential environments.

This Manufacturer's Warranty also does not apply to customer-induced damages or circumstances outside our control, including, but not limited to:

- a. any damage caused by transporting the Product, including by you, the seller, its contractor, our contractors or any other person;
- b. damage or discolouration to the Product caused by accident, fire, water damage, scratching, spills such as acid solvents and dyes or other corrosive materials, ink, paint or "bodily fluids", newsprint transfer or fabric dye, exposure to excessive heat, moisture or dampness, contamination with vermin or insects, transference of perspiration, body oils or the corrosive ingredients contained in personal care products such as hair gels and skin creams;
- c. the normal and expected settling of soft filling such as polyester fibre and leather;
- d. damage or degradation of leather or fabric coverings not properly maintained (i.e. the regular removal of dust and dirt by appropriate means and the application of endorsed cleaning and nourishing leather products as instructed at the time of sale);
- e. leather grain variation, colour variation, wrinkling, markings and scars resulting from the natural features of the hide;

- f. natural settlement of foam due to normal wear and tear;
- g. failure to maintain feather fill as advised by us, resulting in compacted fill;
- h. damage to the Product resulting from repair work carried out by persons other than our authorised contractors or from the use of other than our genuine spare parts;
- i. damage caused by the use of the Product in a manner other than the use for which it was specifically designed;
- j. damage caused by normal wear and tear, including scratches, dents, chips, marks, and accidental breakages;
- k. damage arising from failure to use and care for the Product in a fit and proper fashion according to our instructions as set out in this booklet or as labelled on the Product (including damage due to the application of chemicals, cleaners or conditions not endorsed by us);
- l. damage to the Product caused by war, terrorism, fire, accident, natural disaster, intentional or accidental misuse, abuse, neglect, improper maintenance or use under abnormal conditions;
- m. damage to the Product as a result of excessive use of cleaning products or cleaning agents;
- n. fraud, theft, unexplained disappearance or wilful act; or
- o. any other event, act, default or omission outside our control. Our Manufacturer's Warranty will not be valid if (i) if you transport the Product to an area outside Australia or (ii) if you do not have clear proof of purchase.

## 3. TRANSPORTATION OF PRODUCT AND OTHER EXPENSES

Once you have made your claim, we will either:

- a. send out an authorised contractor or repairer to assess your claim and/or to repair the Product and/or to collect the Product (depending on the situation), or
- b. arrange for the Product to be transported back to our warehouse. You must allow our authorised contractor or retailer to assess the Product or our contractor to pick up the Product for transportation within seven days of our confirmation that we will assess your claim. If your claim is not approved, if you live in a remote area or outside a metropolitan area or if the Product is to be picked up from a location not easily accessible at our discretion, you will be required to pay the travel/labour/inspection/transportation costs which will have been disclosed to you prior to our assessment.

If a claim is not approved, you can request that we make repairs to the Product. Any such services will be provided subject to separate terms and conditions between you and us and for a fee to be determined prior to the repairs being done.

#### 4. HOW TO CLAIM UNDER THE MANUFACTURER'S WARRANTY

To make a claim under this Manufacturer's Warranty, you must contact the seller of your Product within seven calendar days after the defect or damage appears in the Product and prior to the expiry of the applicable Warranty Period. You must provide the following information upon notification of the defect:

1. your name;
2. your phone number;
3. copy of your proof of purchase;
4. product details;
5. details of the defect claimed; and
6. any other details the seller requires.

Once we have received a notification of the defect from the seller, we will determine whether your warranty claim is a claim we will assess and if it is, we will inform you of how we will make the assessment and, if approved, how we will honour it. We may require further information in order to assess your warranty claim, which you will provide without delay. Any decision on a warranty claim will be at our sole discretion.

You can contact the Harvey Norman store where you purchased the product from.

#### 5. MISCELLANEOUS

- a. The Products are handmade products. The size of each individual piece may vary from the sample or any product specifications quoted. For the same reason, the comfort and subjective feel of the goods may vary slightly from Product to Product. These variations are considered normal and in no way will affect the wearability of the Product.
- b. Natural characteristics of the good/s cannot be deemed as a defect (see booklet). Scars, marks and differing pore density and colour are natural characteristics of the leather and are not considered defects. Leather may vary in colour and texture from the original sample as it is a natural product.
- c. Fabrics, leathers, suspension components, cushioning and fillings will show signs of wear and tear with use. Fabrics and leathers will fade and crease. Foam and fillings will soften and form to the shape of the user over time. Depending on the covering and the degree of use, the covering materials, cushion fillings and suspension may need to be replaced periodically at the customer's expense.
- d. Foam is a product that compresses with use. We consider this to be normal wear and tear. The comfort of the seating is subjective, and it is very hard to gauge the degree of firmness or softness. Softening of foam should be expected as a result of normal use and is not to be confused with loss of resilience.
- e. Colour matching orders are taken on the strict understanding that exact matching cannot be guaranteed to be a precise match due to the variations in the natural products used in the manufacture of these goods.

### 3.1 About Reclining Mechanisms

We use one of the best reclining mechanisms available in the market. Proper use of this mechanism will give you lasting comfort. Lounges and chairs with reclining mechanisms give you the choice of changing the inclination of the back, positioning of the legs and changing the seating position. It is important to point out that where recliners are provided in a lounge, it is normal to see gaps as these gaps allow free movement and avoid excessive abrasion.

#### CAUTION

When sitting on a recliner, you must be aware that the arms are anchored at the base of the recliner, and any leaning or sitting sideways across the recliner arms can put pressure on the anchor points and cause buckling of the frame or mechanism. Damage to the frame or mechanism caused in this nature is not covered under the Linea Domo warranty.

This appliance is not intended for use by persons (including children) with reduced physical, sensory or mental capabilities or lack of experience and knowledge unless they have been given supervision or instruction concerning the use of the appliance by a person responsible for their safety. Children should be supervised to ensure that they do not play with the appliance.

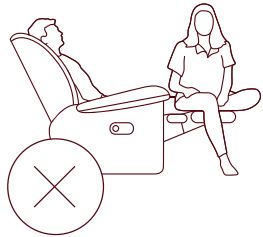

Do not sit on the foot rest.

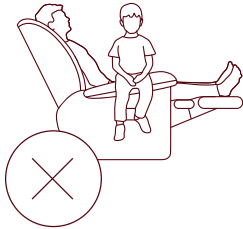

Do not sit on the arm.

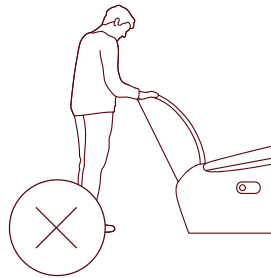

Do not pull or force the recliner.

### 3.2 Fixing Back on Recliner

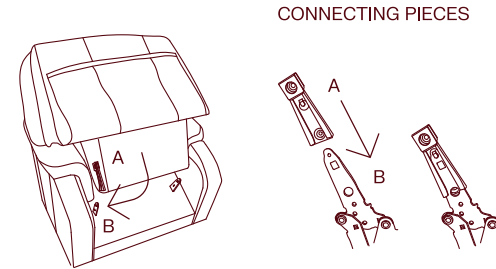

1. Align Piece A to Piece B on both sides of the chair.

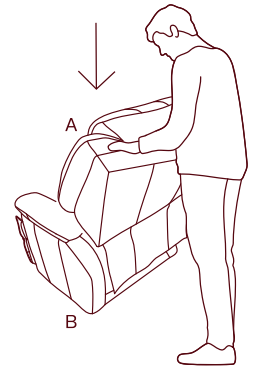

2. Press the back gently with both hands.

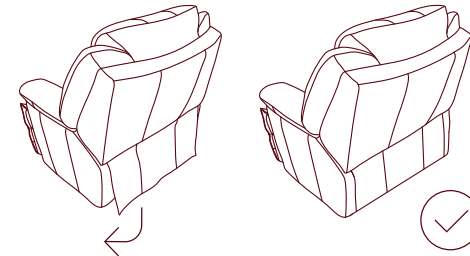

3. Attach the backcloth to the base by using the velcro strip.



### 3.3 Recliner Operating Instructions

#### TO EXTEND FOOTREST

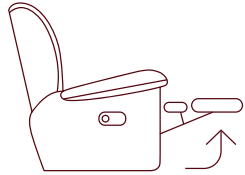

Pull the lever on the side of the chair. The lever will activate the mechanism and extend the footrest.

#### TO RECLINE

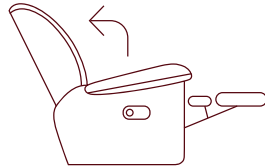

With the footrest extended, lean back. The back is counter-balanced, requiring only minimal body pressure to move smoothly to your desired recline position.

#### TO CLOSE

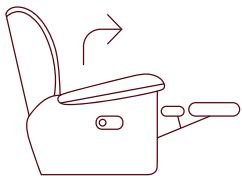

The recline position returns to the upright position by sitting up.

#### TO RETURN FOOTREST



Move your body weight forward and press down with your legs until the footrest returns to the closed position. At this position, it will be locked closed.

### 3.4 Electric Recliner Operating Instructions

#### WHERE TO LOCATE TRANSFORMER

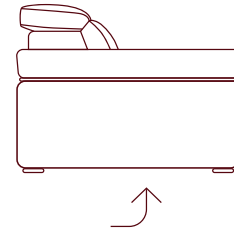

1. Tilt the chair to the side and place it on the floor.

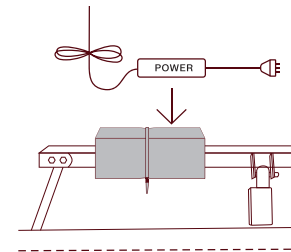

2. Take out the Transformer and power cable from the box.
3. Put the chair in place and connect the power to start using it.

Please note: The backup battery (not provided) for transformers are only for emergency operation during blackout, not for everyday use

#### GENERAL BUTTONS

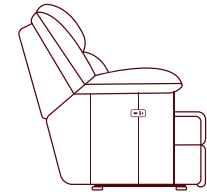

1. Insert the plug fully into the power outlet.

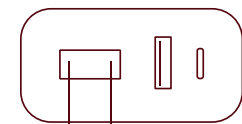
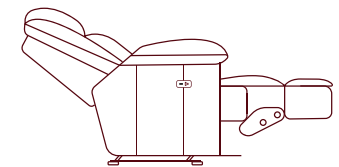

S2 S1

2. Press S1 to activate the mechanism and extend the footrest;
3. Press S2 to return the reclining position and footrest to the closed position.

### TOUCH BUTTONS

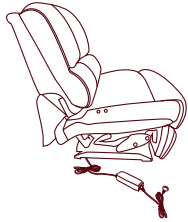

1. Insert the plug into the power outlet.

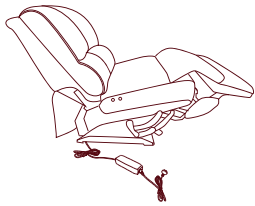

2. Touch the A button to activate the reclining mechanism and extend the footrest.
3. Touch the B button to return the reclining position and footrest.

### EHR

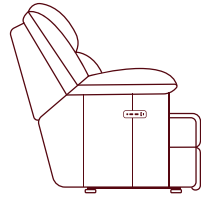

1. Insert the plug into the power outlet.

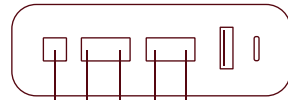
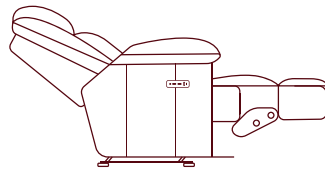

S5 S4 S3 S2 S1

2. Press S1 to activate the reclining mechanism and extend the footrest.
3. Press S3 to raise up the headrest.
4. Press S2 to return the reclining position and footrest to the closed position.
5. Press S4 to return the headrest to the closed position.
6. Or Press S5 Home button to return all parts to the closed position.

### EBR

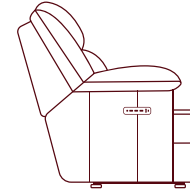

1. Insert the plug fully into the power outlet.

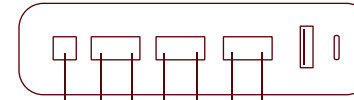
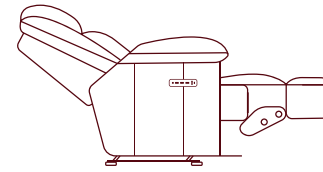

S7 S6 S5 S4 S3 S2 S1

2. Press S1 to activate the reclining mechanism and extend the footrest. Press S3 to raise up the lumbar. Press S5 to raise up the headrest.
3. Press S2 to return the reclining position and footrest to the closed position. Press S4 to return the lumbar to the closed position. Press S6 to return the headrest to the closed position. Or Press S7 Home button to return all parts to the closed position.

## 3.5 Lift Chair

### POSITIONS

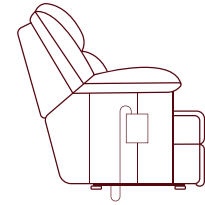

Closed position

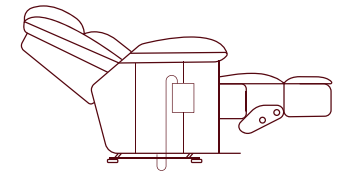

Reclining position

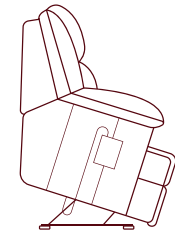

Lifted position

## 3.6 Controllers

### SINGLE MOTOR LIFT CHAIR

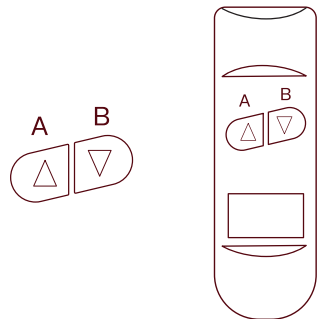

#### Button A

- To retract the footrest and back to return to the seating position.
- To raise the chair to the lift position.

#### Button B

- To extend the footrest and back.
- To lower the chair down.

### DUAL MOTOR LIFT CHAIR

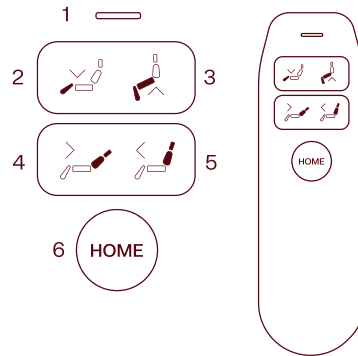

1. Power light
2. Footrest up
3. Footrest down and lift
4. Back down
5. Back up
6. Back to closed position

### EHR LIFT CHAIR

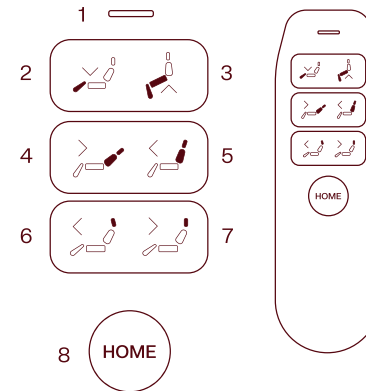

1. Power light
2. Footrest up
3. Footrest down and lift
4. Back down
5. Back up
6. Head up
7. Head down
8. Back to closed position

### EBR LIFT CHAIR

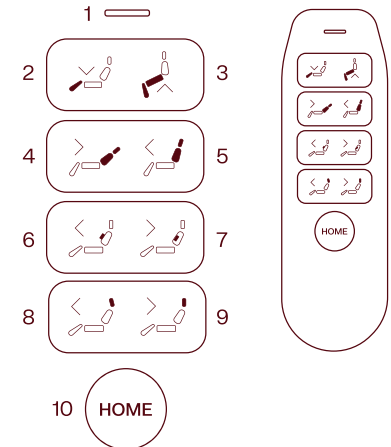

1. Power light
2. Footrest up
3. Footrest down and lift
4. Back down
5. Back up
6. Lumber up
7. Lumber down
8. Head up
9. Head down
10. Back to closed position

## 3.7 Troubleshooting & Warnings

### TROUBLESHOOTING

If you are having any issues, please try the following solutions.

- Check that all plugs are plugged into a wall outlet and are secure. Please check that the wall outlet is switched on. Check that all switches at the rear of the suite are switched on.
- Check to ensure that all connection cords are properly connected, as per the instructions in this booklet. There are multiple connections, any of which being too loose may cause performance issues.
- Try plugging the suite into a different wall outlet.
- The USB ports included in our products are low voltage. Please use the 240V socket in the charge station if your product includes one if you are charging a larger device or require a faster charge.
- Unplug the suite from the wall for 5 minutes to reset all electrical components.
- Ensure there is nothing obstructing the recliner movement. Please check all connections before contacting the store for help.

### WARNINGS

- Improper use or installation may result in the risk of fire, electric shock and/or injury. We assume no liability for any eventual damages caused by improper use or inappropriate handling or by any other noncompliance with the instructions in this manual.

## 4.0

## Sofa Assembly

- Do not sit or place additional weight on the arms, back or open footrest. Damage caused as a result of excessive force is not covered under warranty.
- This Product is very heavy. Only move this Product by lifting the main body. Never drag by the footrest, back or armrest.
- Return this Product to the full upright position to stand safely and prevent a tripping hazard.
- Do not operate this Product if the damage is visible in any form.
- Do not modify or use unauthorised substitute parts.
- This Product is not intended to be used as part of a health care plan. Consult your medical professional before operating if you are taking medication or have physical limitations.
- Before commencing cleaning or maintenance, please ensure this Product is disconnected from the power outlet and the back is in the full upright position.
- Cease operation and disconnect from the power outlet if you ever detect a burning odour or smoke coming from the Product.
- Check the condition of the power cord, electrical cords, Transformer, plug and connector on a monthly basis. Do not operate if wear is visible.
- Ensure the power cord, electrical cords and Transformer are clear of moving parts and not trapped underneath the base.
- Position the power cord to minimise a tripping hazard.
- We recommend the use of a surge protector (not included).

## 4.1 Sofa Bed

### ABOUT SOFA BED MECHANISMS

We use one of the best sofa bed mechanisms that are available. A lounge with a sofa bed mechanism gives the flexibility of lounge to be used in a formal and informal situations. The sofa bed action allows the lounge to be transformed into a bed which may come in handy when extra beds are needed.

Careful and proper use of the mechanism will give years of comfort. Following operating, instructions may assist in getting the best out of a lounge that has a sofa bed mechanism

**Note:** Remove all packaging material and transport legs and attach the lounge legs supplied.

### IMPORTANT OPERATIONAL FEATURES TO ENSURE A LONG LIFE FOR YOUR NEW SOFA SLEEPER.

Your new sleeper mechanism is designed to provide years of reliable service. To help your sleeper last as long as possible, Please note these suggestions:

- Don't sit on the end of the bed.
- Don't fold with linens or pillows on the mattress.
- Don't jump on the bed.

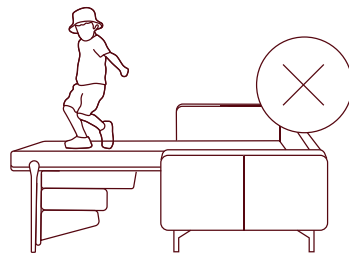
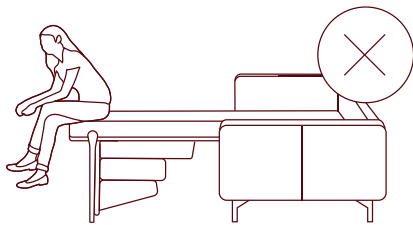

### TO OPEN



1. Pull the strap up with two hands and pull it towards you.

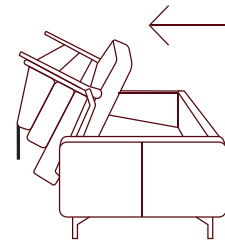

2. Grasp the mechanism bar with one hand while still holding the strap and continue to lower the bed.

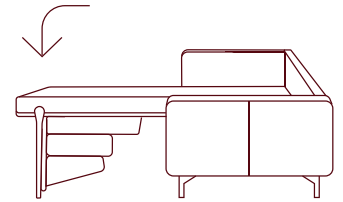

3. Lower it down gently to the floor.
4. To close, Reverse steps 1, 2, and 3.

## 4.2 Standard Feet

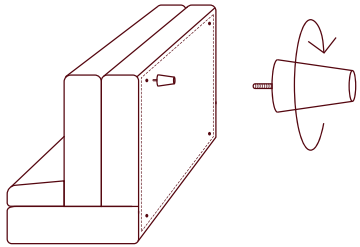

1. Lift the sofa from the base and turn it so that its back rests on the floor;
2. Position the feet in the screw holes and rotate them clockwise as above picture until the feet are mounted firmly;
3. Return the sofa to an upright position, as shown in the pictures. Assembly Instructions For Modular

## 4.3 Bracket

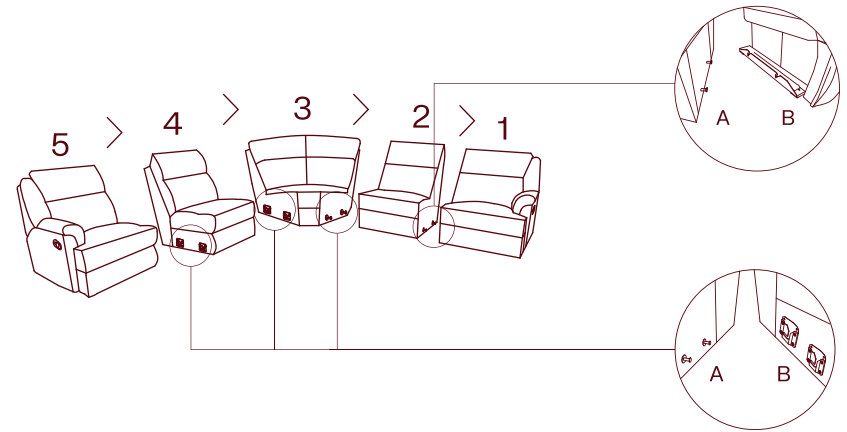

1. Align the components.

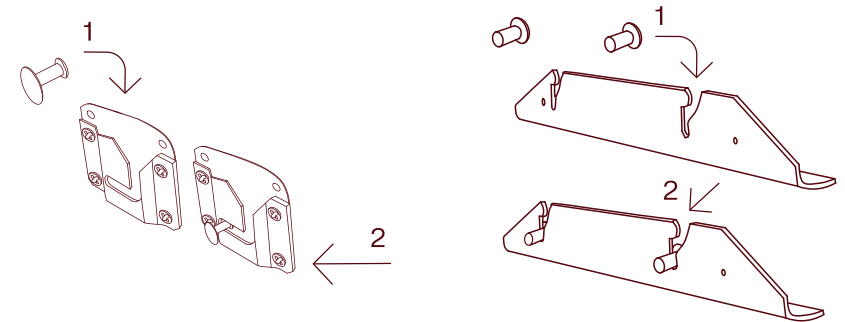

2. Raise piece A and insert it into piece B.
3. Position the components closely and ensure that they are firmly connected.



Kato in Villa  
leather range

## 4.4 Croc Lock

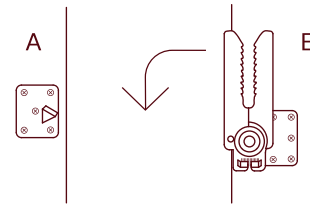
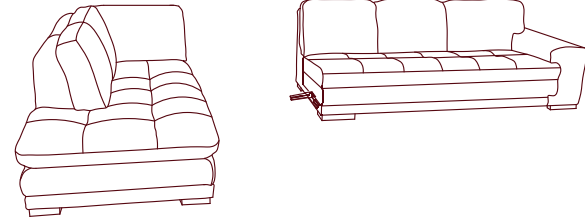

1. Rotate the croc lock towards the outside of the sofa;

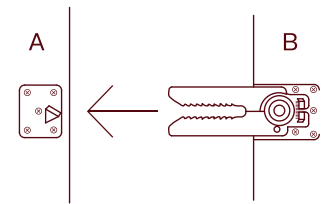

2. Insert piece A into piece B and tighten them to the appropriate position.

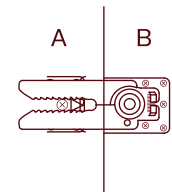

## 4.5 Locking Clips

Proudly Australian Owned.

Made with care.  
Made to last.

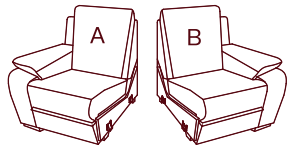

- 
1. Line up the component parts;
  2. Raise A and lower piece C into piece D.



LINEA DOMO



SINCE 2005